

## IMPORTANT INFORMATION

### Encore<sup>®</sup> 60 / 80 / 100

TT1690/TT1691/TT1700/TT1701/TT1702/TT1703  
TD1690/TD1691/TD1700/TD1701/TD1702/TD1703



#### Disconnect electricity supply before installation

To be installed by qualified personnel only, in accordance with current building and wiring regulations

When installing, we recommend wearing disposable gloves to avoid fingerprinting to the paint work of the luminaire.

Ensure a minimum 1m clearance between the lens and any objects directly in front of it to prevent overheating.

Read leaflet fully before installation.

**Hacel**<sup>®</sup>  
Fluent in Lighting

THE SILVERLINK, WALLSEND, NEWCASTLE UPON TYNE,  
TYNE & WEAR, NE28 9ND

Technical: (0191) 280 9914  
Email: [technical@hacel.co.uk](mailto:technical@hacel.co.uk)  
Web: [www.hacel.co.uk](http://www.hacel.co.uk)

05/2026

## Installation Track Version

1

Turn the lever at one end of the Track Adapter so that the electrical connections are withdrawn into the Track Adapter.

For DALI Track Adapters there are levers at both ends of the Adapter and both should be turned so that all electrical connections are withdrawn into the Track Adapter

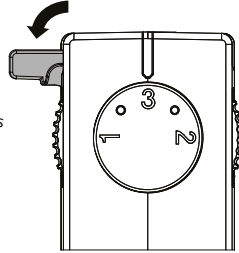

4

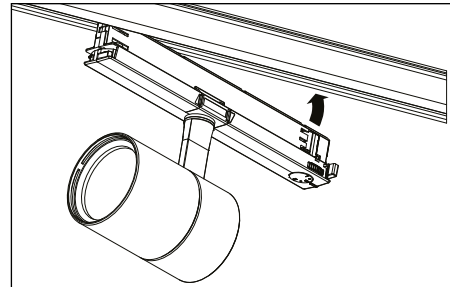

Offer the luminaire up to the track at a slight angle so that the lever and dial are slightly lower than the opposite end of the Track Adapter.

7

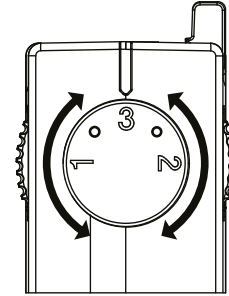

If the circuit selector dial was set at 0, rotate it to select 1, 2 or 3 depending on the circuit required for that luminaire.

2

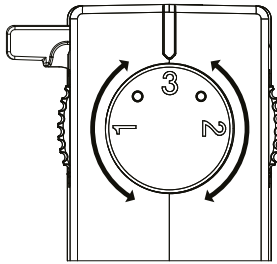

Rotate the dial to select 0 (off), 1, 2 or 3 depending on the circuit required for that luminaire, by aligning the number with the raised mark.

5

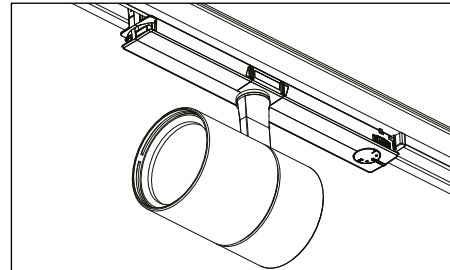

Insert the luminaire into the track ensuring that the Track Adapter is properly located.  
**(luminaire weight 0.8kg)**

3

The Track Adapter will only fit into the track in one orientation to ensure correct polarity.

Do not force the Track Adapter into the track, if it proves difficult to insert, try the other orientation.

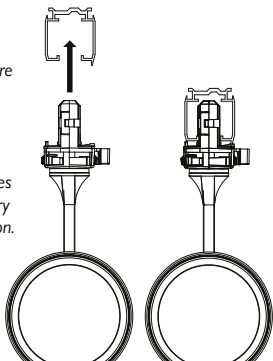

6

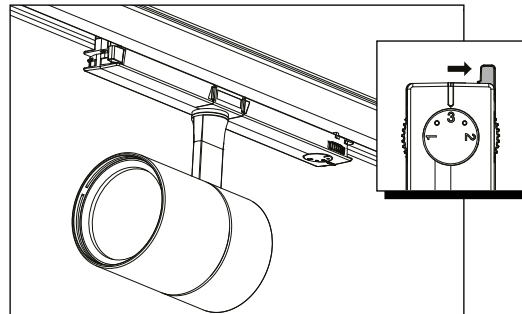

Turn lever(s) back to engage the electrical connections.